



QUADRO SYNC

DU-06574-001_v01 | October 2012

User's Guide



DOCUMENT CHANGE HISTORY

DU-06574-001_v01

Version	Date	Authors	Description of Change
01	October 16, 2012	AP, SM	Initial Release

TABLE OF CONTENTS

Getting Started	1
System Requirements	1
Board Overview	2
Board Installation	3
Quadro Display Driver	4
Working with Quadro Sync	5
Multi-GPU Mosaic Configuration	6
Mosaic Overview	6
Configuring Mosaic	7
Frame Lock Configuration	8
Connecting Nodes in a Visualization Cluster	8
Frame Lock Connector LEDs	9
Visualization Cluster Setup Order	10
Restarting a Visualization Cluster	11
Windows Driver Configuration	11
Enabling Frame Lock	13
Configure Frame Lock Clients	15
Linux Driver Configuration	16
Set Driver Security to Allow Remote Management	16
Configure Frame Lock	17
Sync to an External Timing Source	20
External Timing Sources	20
Synchronize to an External Sync Source for Windows	21
Synchronize to an External Sync Source for Linux	22
Monitoring Display Synchronization	23
Board Level Status Indicator	23
Frame Lock and Stereo Sync Status LEDs	24
System Topology Viewer for Windows	26
Sync Timing Limits	28
Compliance and Certifications	29
Important Safety Information	30

LIST OF FIGURES

Figure 1.	Quadro Sync Board Overview	2
Figure 2.	Quadro Drivers Compatible with Quadro Sync	4
Figure 3.	3 x 3 Mosaic with Quadro Sync	6
Figure 4.	NVIDIA Driver Downloads	7
Figure 5.	Frame Lock Connections on Timing Server	9
Figure 6.	Board Level Status Indicators.....	24
Figure 7.	Frame Lock and Stereo Sync Status LEDs	25
Figure 8.	System Topology Viewer for Windows.....	26

LIST OF TABLES

Table 1.	Sync Timing Limits	28
Table 2.	Symbols on Equipment.....	31

GETTING STARTED

The NVIDIA Quadro® Sync board is designed to fit into a free PCI Express slot within the system. It does not require power from the PCI Express connector on the motherboard and is designed to be with PCI Express and PCIe connectors.

SYSTEM REQUIREMENTS

- ▶ NVIDIA® Quadro® Professional Graphics Boards
 - The Quadro Sync board supports up to 4 matching Quadro graphics processing units (GPUs) which are compatible with Sync
 - For an up to date list of the Quadro boards compatible with Sync see www.nvidia.com/sync
- ▶ Operating Systems
 - Windows 7: 64-bit recommended, 32-bit supported
 - Linux: 64-bit recommended, 32-bit supported
 - Limited support for Windows XP 32-bit and 64-bit: 2 GPUs per Quadro Sync board, 2 displays per GPU and no support Multi-GPU NVIDIA® Mosaic features
- ▶ Driver
 - R304 branch display drivers will support Quadro Sync for GPU topologies that do not use Mosaic
 - R310 branch and newer display drivers support Quadro Sync with Mosaic topologies
- ▶ Chassis Requirements
 - Single free PCIe slot
 - 6-pin PCI or SATA power connector

BOARD OVERVIEW

The Quadro Sync board is an accessory board to the Quadro Professional GPU. On the top edge are four connectors to connect it to the GPUs. The cables are included in the box.

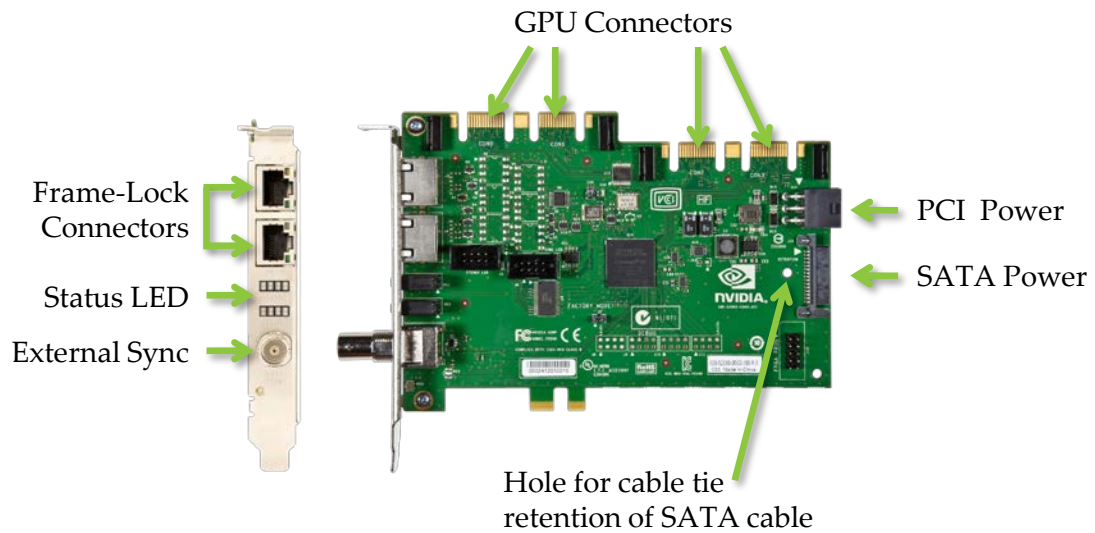

Figure 1. Quadro Sync Board Overview

For high vibration environments there are cable retention clips, not pictured, which hold all cables securely in place on both the Quadro Sync board and Quadro GPU. Since the SATA power connector has no physical retention the board has a hole which can be used to secure the cable with a cable tie.

BOARD INSTALLATION

Prior to installing the Quadro Sync board, make sure to power down the machine and unplug the power connector.

1. Place the Quadro Sync board in a free slot, note the PCIe edge fingers may not bottom out in the PCIe slot.
2. Connect the Sync board and up to four Quadro boards with included ribbon cables. On the Quadro board make sure to connect to the connector labeled “SYNC | SDI”. There is no need to connect the Quadro boards to the connectors on the Quadro Sync board in any particular order.
3. Connect a 6-pin PCIe or SATA power connector.
4. Optional: Place the included cable retention clips on both the Quadro Sync board and Quadro board(s).

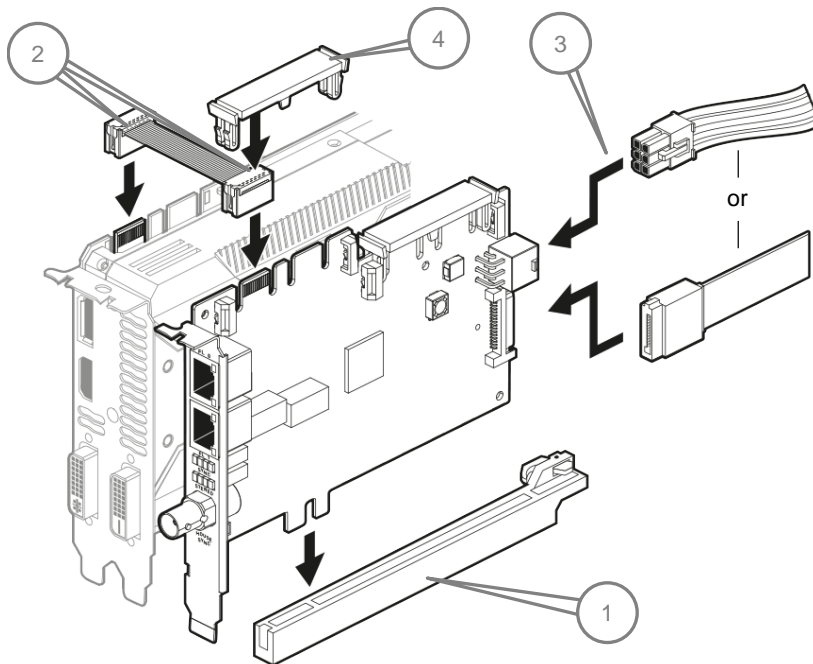

Note: When properly installed the PCIe finger on the Quadro Sync board may not touch the bottom of the PCIe slot.

When using Quadro Sync in a system that supports NVIDIA SLI® an SLI bridge does not need to be connected unless you are planning to use SLI specific features like SLI Frame Rendering or SLI Anti-Aliasing. These SLI modes are not compatible with most of the features of Sync.

QUADRO DISPLAY DRIVER

Quadro Sync does not require a dedicated driver; all the files needed to operate it are included in the Quadro display driver. Drivers are available on the NVIDIA Web site at www.nvidia.com/drivers. When choosing the drivers for use with Quadro Sync, make sure to select the following from the pull down lists:

- ▶ “Quadro Sync Series” from the **Product Series** pull down list
- ▶ “Quadro Sync” from the **Product** pull down list

NVIDIA Driver Downloads

Option 1: Manually find drivers for my NVIDIA products.

Product Type:	Quadro	▼
Product Series:	Quadro Sync Series	▼
Product:	Quadro Sync	▼
Download Type:	Quadro ODE Graphics Driver	▼
Operating System:	Windows 7 64-bit	▼
Language:	English (US)	▼

SEARCH

Option 2: Automatically find drivers for my NVIDIA products.

Figure 2. Quadro Drivers Compatible with Quadro Sync

Quadro Sync is supported for single GPU operations with the R304 branch driver, multi-GPU features are supported in the R310 and newer branch drivers.

WORKING WITH QUADRO SYNC

Whether working with a single node or visualization cluster the Quadro Sync board provides multiple forms of display synchronization:

- ▶ **Multi-GPU Mosaic:** Mosaic is a software technology that abstracts multiple physical displays into a larger virtual display. When the virtual display spans across multiple GPUs, the Quadro Sync board synchronizes the GPUs to ensure all the displays stay aligned.
- ▶ **Frame Lock:** Synchronize multiple displays, in one machine or spread across multiple machines in a cluster. For Frame Lock a single display is chosen as the timing master and all other displays in the cluster align to it. Frame Lock can be used with individual physical displays and single or multi-GPU Mosaic displays.
- ▶ **Sync to an External Timing Source:** Aligns a selected display to an external timing generator. The selected display can be a Mosaic or physical and can be used as the Frame Lock master if desired.

The Quadro Sync board supports mixing and matching the different synchronization options to build the correct configuration your installation needs. Installations with Quadro Sync can become complex and architecture decisions can impact performance and reliability, for questions on how to architect systems with Quadro Sync or Mosaic contact QuadroSVS@nvidia.com.

MULTI-GPU MOSAIC CONFIGURATION

MOSAIC OVERVIEW

Mosaic is a technology that combines multiple displays or projectors into a single virtual display. It's capable of creating a projector overlap region or subtracting the area behind screen bezels to create a single unified display surface. With Quadro Sync and supported Quadro GPUs up to 16 displays can appear as one to the operating systems and any application that runs on them. The image in Figure 3 is an example of a 3 × 3 display wall connected to 3 Quadro K5000 graphics boards.

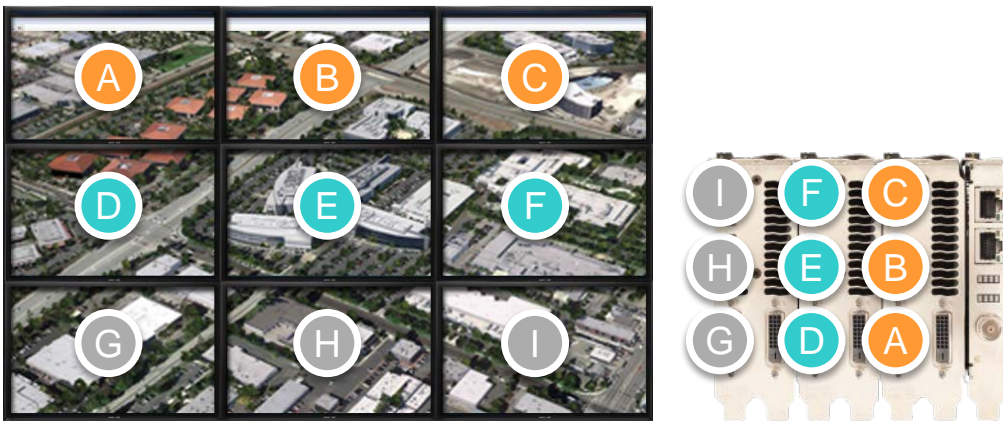

Figure 3. 3 x 3 Mosaic with Quadro Sync

When working with multi-GPU Mosaic, Quadro Sync automatically keeps all the displays that are part of the Mosaic synchronized.

For more information on Mosaic refer to the NVIDIA Web site at www.nvidia.com/svs.

CONFIGURING MOSAIC

No special configuration is required for Mosaic; configure it either through the control panel, with the configureMosaic utility or through one of the programmatic interfaces.

The configureMosaic utility is not part of the standard driver download but is easily downloaded from www.nvidia.com/drivers.

NVIDIA Driver Downloads

Option 1: Manually find drivers for my NVIDIA products.

Product Type:	Quadro	▼
Product Series:	Quadro Series	▼
Product:	Quadro K5000	▼
Download Type:	Mosaic Utility	▼
Operating System:	Windows 7 64-bit	▼
Language:	English (US)	▼

Figure 4. NVIDIA Driver Downloads

Mosaic is compatible with the other synchronization methods covered in this user's guide. When combining Mosaic with other forms of synchronization make sure to enable Mosaic first then continue with synchronizing.

FRAME LOCK CONFIGURATION

Frame Lock synchronizes all the selected displays in a system and across systems in a cluster. A single display is selected as the timing master and the Quadro Sync boards will adjust all the other displays to synchronize with it. This operation may take a few minutes.

CONNECTING NODES IN A VISUALIZATION CLUSTER

If using the multi-node synchronization features of Quadro Sync the nodes in the cluster will need to be connected together. Connecting the nodes require CAT-5 Ethernet cables that are not included. It is recommended that you use high quality cables, using the shortest length possible for your installation. Do NOT use Ethernet hubs or switches to branch or extend the signal. Quadro Sync is not compatible with TCP/IP protocols and the board will not operate if it connected to networking equipment.



CAUTION: Do not connect the Quadro Sync board to TCP/IP networking equipment.

Choose one node as the timing master, the machine that will control the timing on all the others. For clusters using active stereo it is recommended that the timing master also drive the stereo sync output. From the timing master, connect a CAT 5 cable between the Frame Lock connectors on the timing master and a client machine, it does not matter which connector you use. It is recommended to create two signal chains off the timing master like in the following diagram (Figure 5).

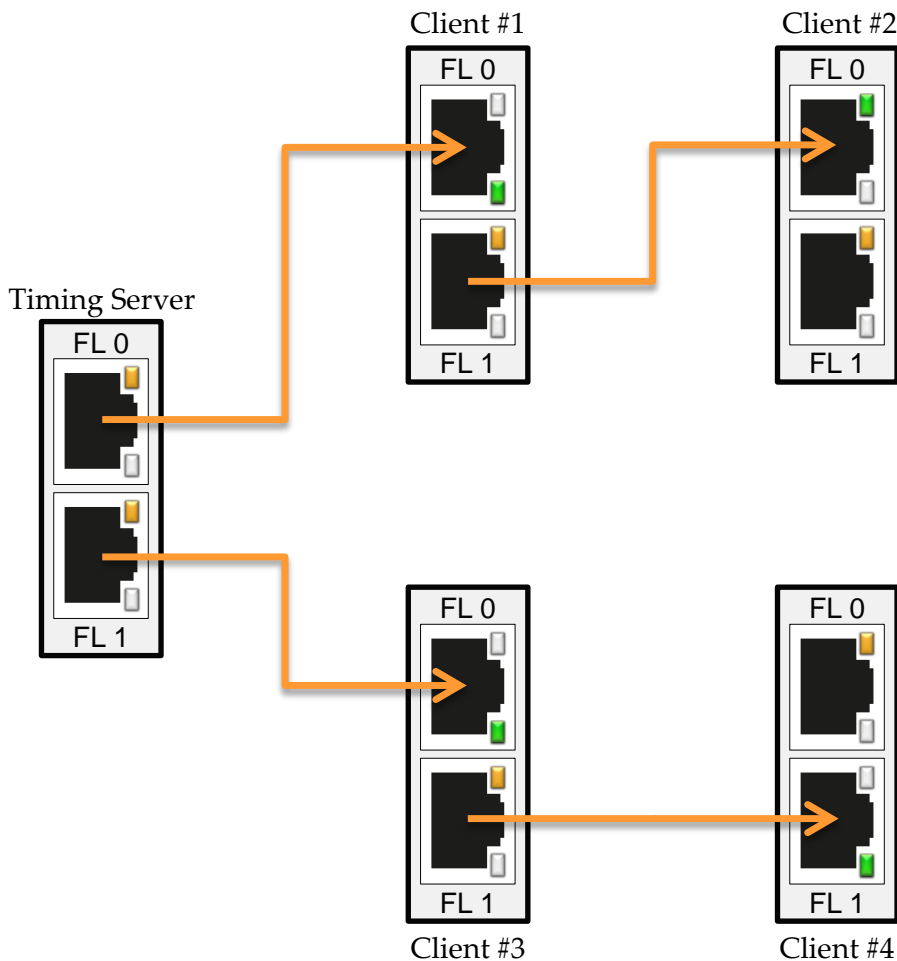

Figure 5. Frame Lock Connections on Timing Server

FRAME LOCK CONNECTOR LEDS

The Frame Lock connector LEDs indicate how the frame lock signal is flowing from one Quadro Sync board to the next. The light indicates if the port is receiving a Frame Lock signal or sending a Frame Lock signal. The ports will auto-configure so different nodes in the cluster may have different LED configurations.

Frame Lock LED Status



Port is an output but no signal is present



Port is an input but no signal detected



Port is an output and sending a signal, the frequency of the blinking is the refresh rate of the signal



Port is an input and receiving a signal, the frequency of the blinking is the refresh rate of the signal

When connecting the Frame Lock ports, the timing server will send two outputs and all the other nodes will configure themselves to one output and one input.

VISUALIZATION CLUSTER SETUP ORDER

When configuring a visualization cluster the order of operations for configuration is important:

1. Start with the Timing Master
 - a) Enable Sync to Vertical Blank
 - b) Enable stereo with the correct stereo mode if using stereo
 - c) Configure and enable the timing master
2. Configure each client machine
 - a) Enable Sync to Vertical Blank
 - b) If using stereo set and enable the same stereo type as the timing master
 - c) Enable Frame Lock on each machine

RESTARTING A VISUALIZATION CLUSTER

Similar to configuration a cluster should be re-started in a particular order to minimize the synchronization time:

1. Start all the client machines
2. Once all client machines are stable start the Timing Master

Depending on the configuration it can take many minutes for a cluster to fully synchronize.

WINDOWS DRIVER CONFIGURATION

Before configuring any of the synchronization modes verify in the NVIDIA Control Panel that the Vertical Sync setting is on and if using stereo that the correct Stereo display mode is selected and enabled. For best performance in a cluster it is recommended that you select the Workstation App – Dynamic Streaming driver preset as well.

1. Open the **NVIDIA Control Panel** and select **Manage 3D Settings**
2. Select **Workstation App-Dynamic Streaming** as the Global Preset

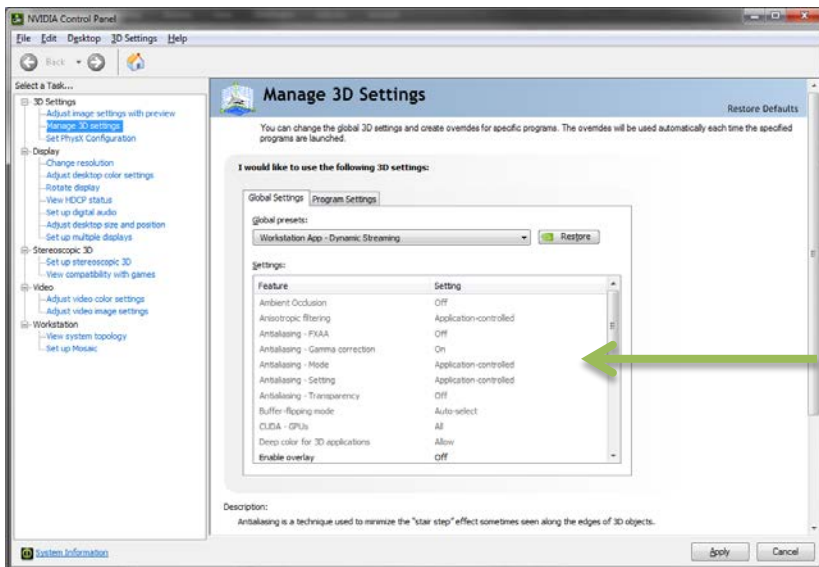

3. Enable Vertical Sync

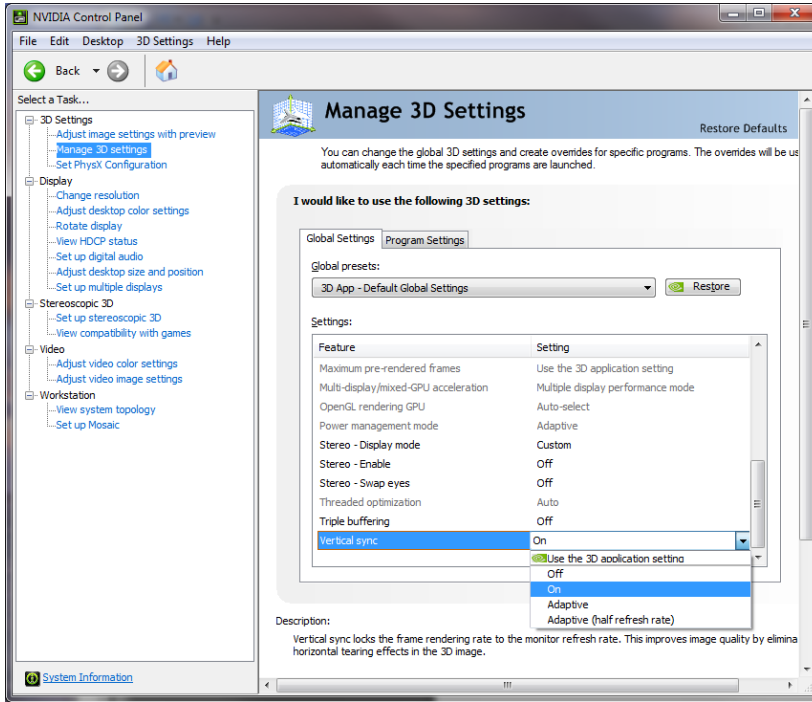

4. If using stereo Select the **Stereo-Display Mode** and enable Stereo with the **Stereo-Enable** entry

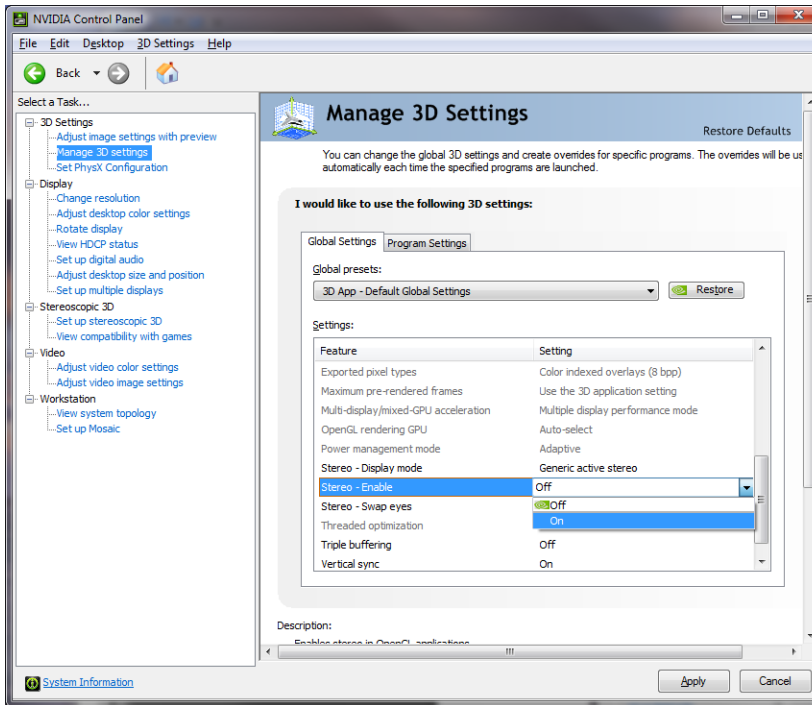

Enabling Frame Lock

When enabling Frame Lock across a cluster you must define a display to be the timing server which all the clients will then connect to. Following the guidelines in the “Connecting Nodes in a Visualization Cluster” section of this guide, it is recommended this node be in the “middle” of the cluster.

For best results synchronizing the cluster configure the Timing Master first, then the client machines so you can verify each client synchronizes correctly as you add it. After the cluster is configured it is recommended to re-boot the cluster in the opposite order: clients then Frame Lock master.



Note: When rebooting the cluster after configuration boot the client nodes first, then once the clients are stable boot the timing master.

Configure Frame Lock Master

To enable Frame Lock on the master open the Synchronize Displays tab in the NVIDIA Control Panel.

1. Open the **NVIDIA Control Panel** and select **Synchronize Displays**
2. Select “The timing server is **On this system**” radio button

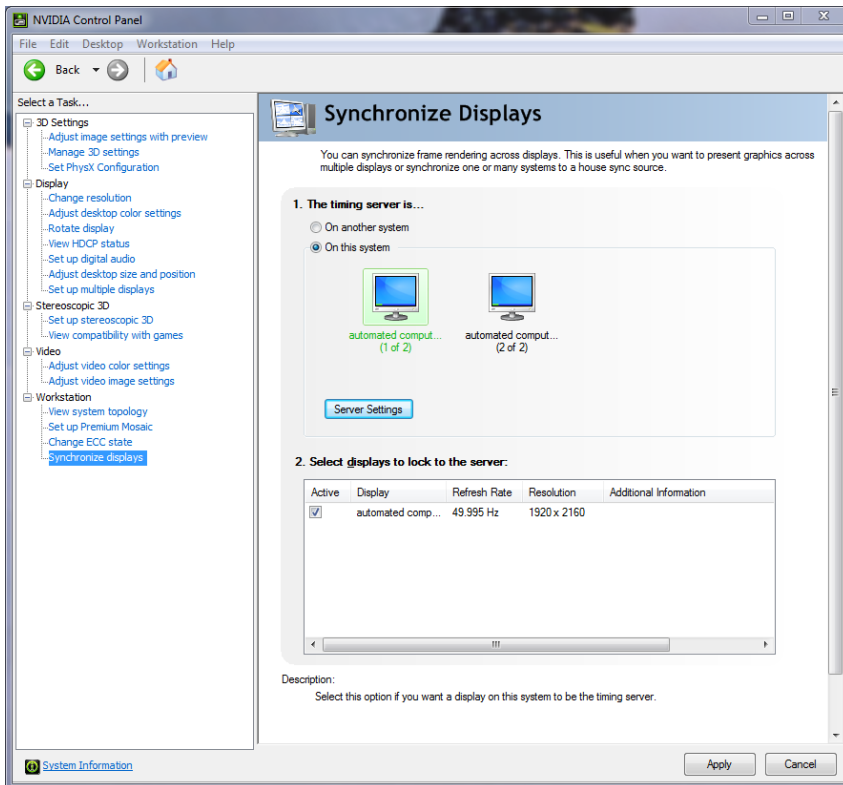

Note: Master node refers to the node that is used as the Timing Server. There can only be one Timing Server in a cluster. All other nodes are commonly referred to as “clients” or “slaves.”

If the system has multiple displays, the driver automatically selects the primary display to be the timing server and all other displays are the clients. To change the configuration, click the icon of the display that you want to be the timing server

3. Press **Apply**.

Configure Frame Lock Clients

The clients machines are also configured through the synchronize displays section of the NVIDIA Control Panel. Since there is already a timing master on the chain when you open the control panel it will only offer the option to synchronize to the master.

1. Open the **NVIDIA Control Panel** and select **Synchronize Displays**
2. Select the displays to synchronize from the box
3. Press **Apply**

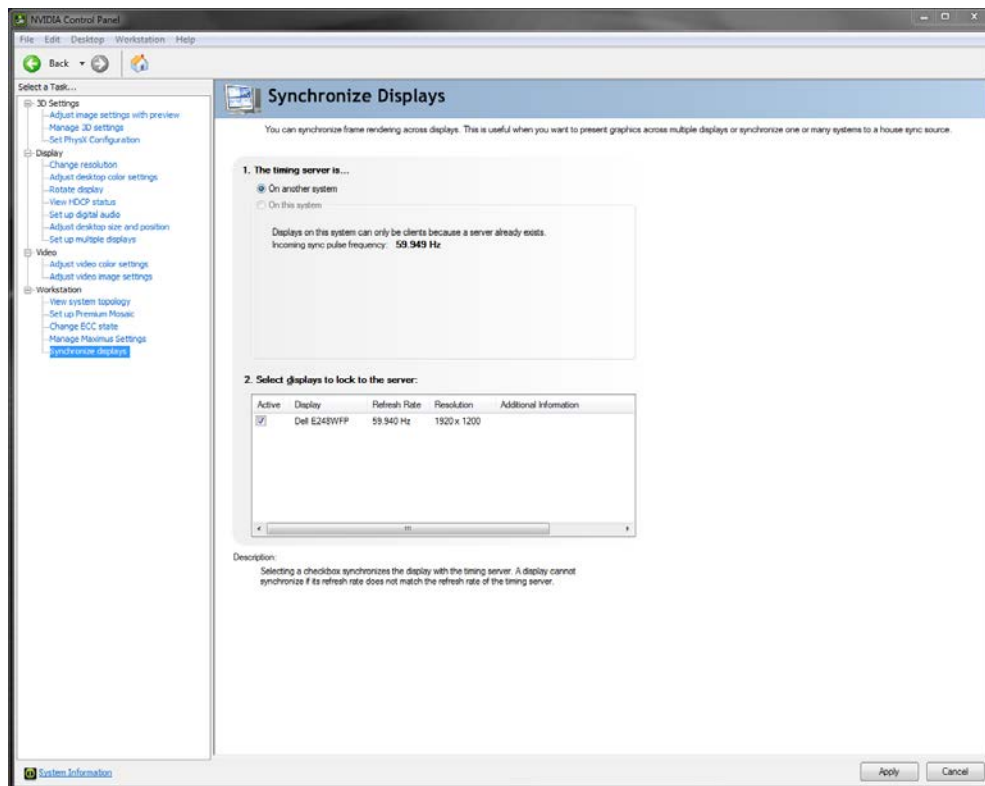

During the synchronization the displays may blink as they adjust their timing. The Status LEDs on the Quadro Sync board and the System Topology Viewer in the control panel will report when the cluster is synchronized.

Note: The Quadro Sync board requires the timings of all displays be within ± 20 ppm to properly synchronize. See the "Sync Timing Limits" section for more information.

To disable Frame Lock reverse the process.

LINUX DRIVER CONFIGURATION

The NVIDIA Control Panel on Linux allows one node to manage all nodes in the cluster. To work properly the security settings need to be set properly or client nodes may not appear.

Set Driver Security to Allow Remote Management

Any X Server can be added to the frame lock group, provided that

1. The system supporting the X Server is configured to support frame lock and is connected via RJ45 cable to the other systems in the frame lock group.
2. The system driving nvidia-settings can communicate with the X server that is to be included for frame lock. This means that either the server must be listening over TCP and the system's firewall is permissive enough to allow remote X11 display connections, or that you've configured an alternative mechanism such as ssh(1) forwarding between the machines.

For the case of listening over TCP, verify that the "-nolisten tcp" commandline option was not used when starting the X server. You can find the X server commandline with a command such as

```
% ps ax | grep X
```

If "-nolisten tcp" is on the X server commandline, consult your Linux distribution documentation for details on how to properly remove this option.

For example, distributions configured to use the GDM login manager may need to set "DisallowTCP=false" in the GDM configuration file (e.g., /etc/gdm/custom.conf, /etc/X11/gdm/gdm.conf, or /etc/gdb/gdb.conf; the exact configuration file name and path varies by the distribution). Or, distributions configured to use the KDM login manager may have the line

```
ServerArgsLocal=-nolisten tcp
```

in their kdm file (e.g., /etc/kde3/kdm/kdmrc). This line can be commented out by prepending with "#".

3. The system driving nvidia-settings can locate and has display privileges on the X server that is to be included for frame lock.

A system can gain display privileges on a remote system by executing

```
% xhost +
```

on the remote system. See the xhost(1) man page for details.

Configure Frame Lock

1. On the master machine open the NVIDIA X Server Settings and select **Frame Lock**

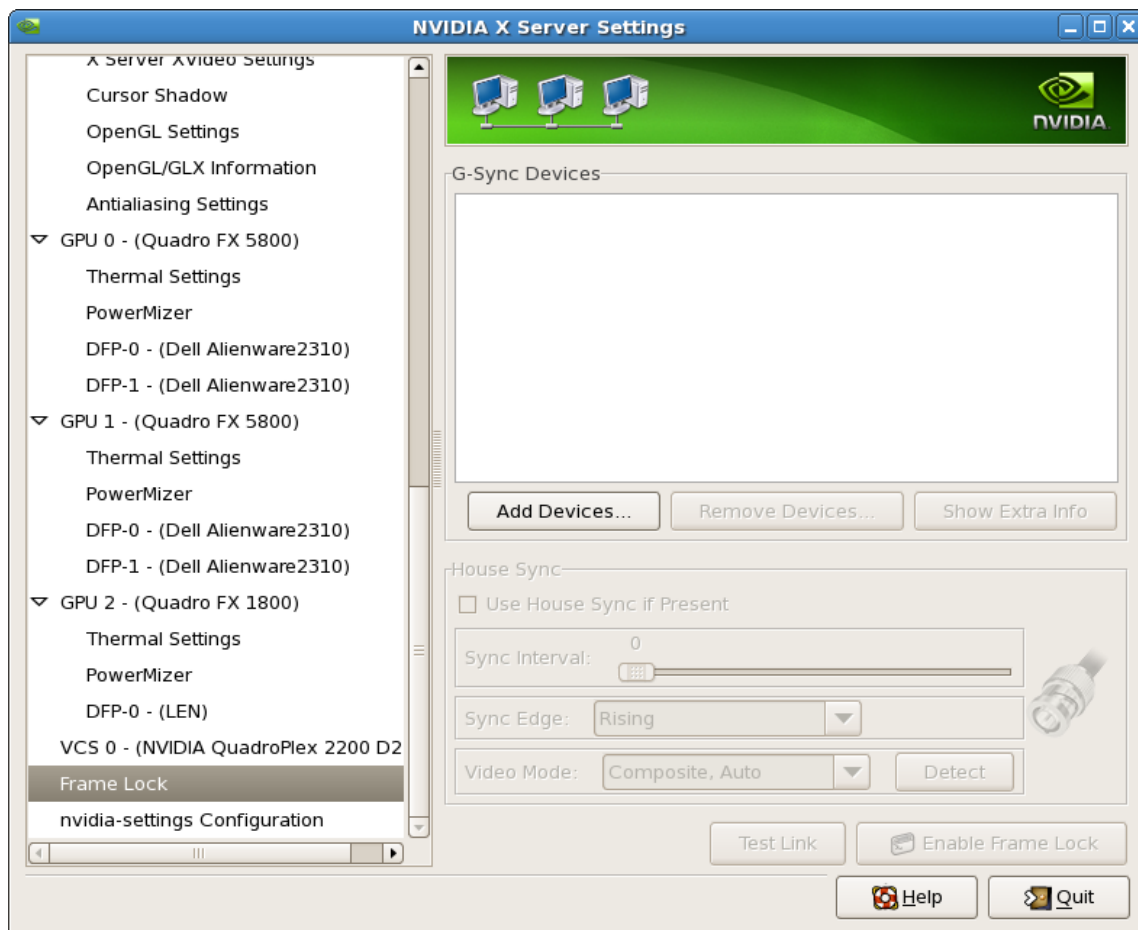

2. Click **Add Devices...** and enter the name of the hostname/ip address and XServer ID of the XServer you want to add. For example localhost:0.0 or in this case our machine named viz0:0.0.

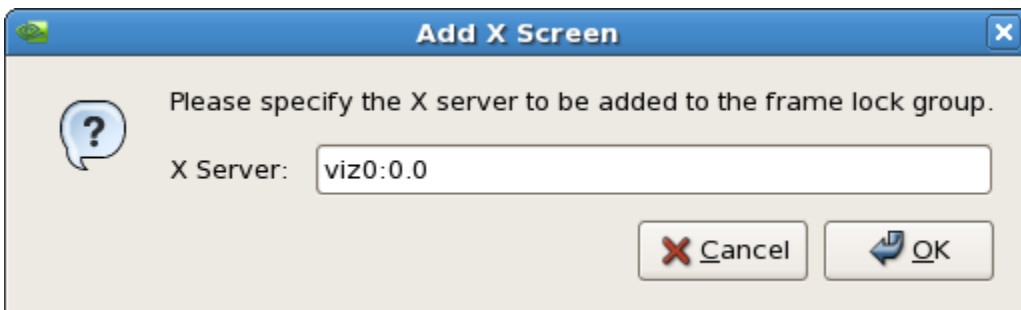

3. Select the display that is the Server and those that are clients. There can only be one server per Frame Lock group

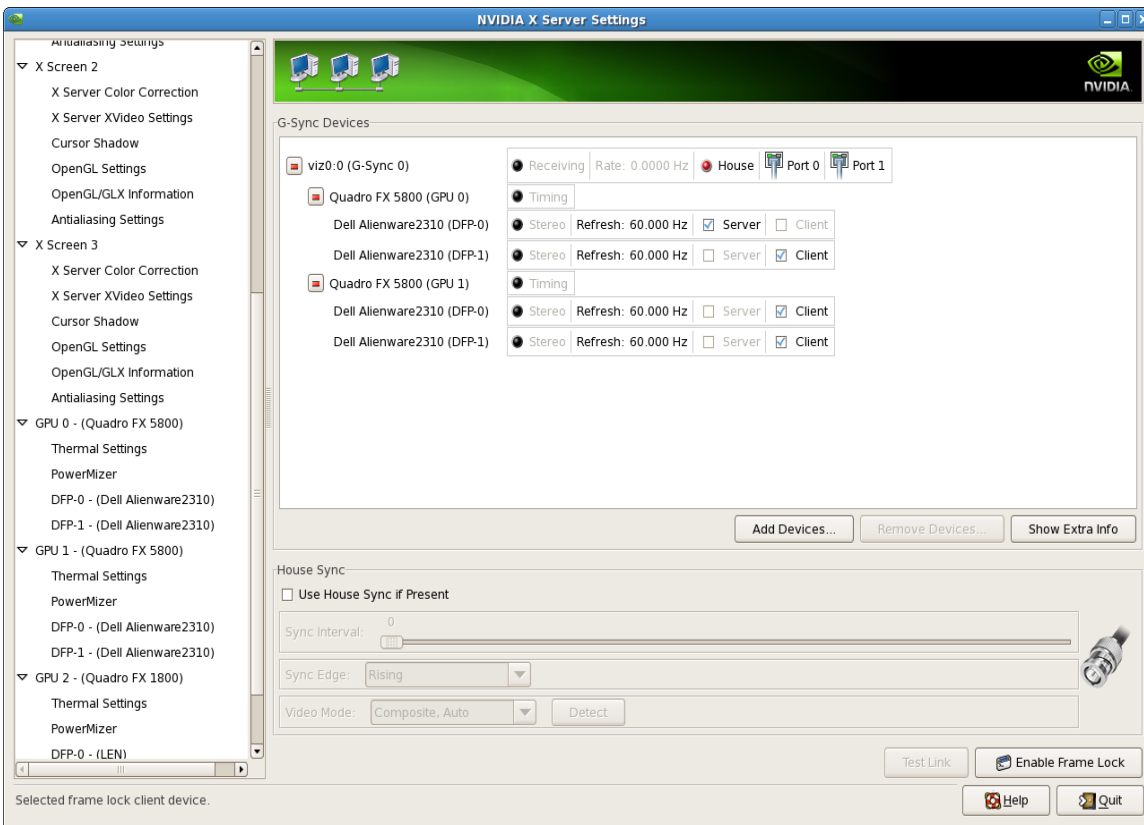

4. Add the other nodes in the same way as step 2 and then set the Client displays as desired

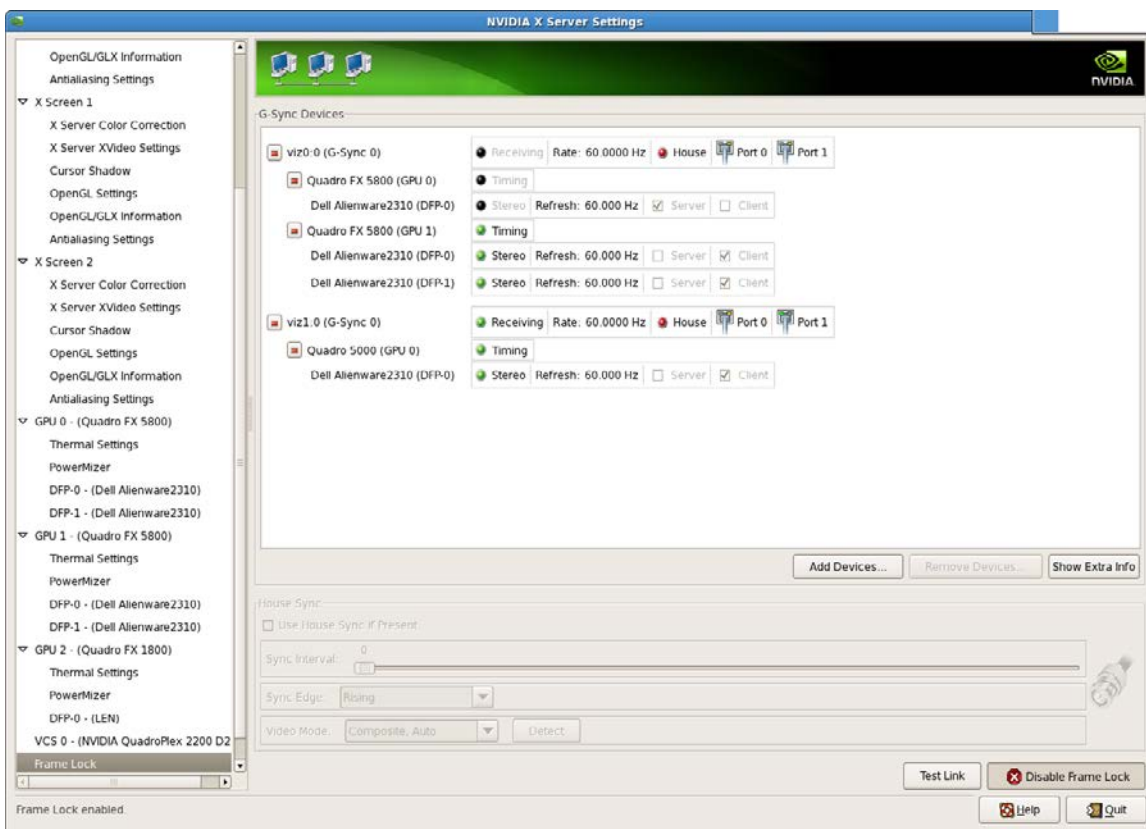

SYNC TO AN EXTERNAL TIMING SOURCE

EXTERNAL TIMING SOURCES

The Quadro Sync board supports three types of external timing sources through the BNC connector on the bracket.

- ▶ TTL: 3.3V, 50% duty cycle, high impedance
- ▶ Bi-Level Composite (NTSC/PAL): 75 Ω impedance
- ▶ Tri-Level Composite (HDTV): 75 Ω impedance
 - SMPTE Standard 240 compliant



CAUTION: Using timing signal Voltages above specification: +3.3 V for TTL, ± 300 mV for Composite will damage the Quadro Sync board.



Note: When using TTL Sync it is important to use a high quality signal generator as variances in the external sync frequency will cause the displays to blink as they adjust their timings to follow the wandering input signal.

When a valid signal is connected to the BNC connector, the LED below it will illuminate solid green. Once the Quadro Sync board is using the external signal the same LED will flash green at the rate of the incoming sync signal.

When using an external sync both Windows and Linux will identify the incoming sync type and configure the board to use it at the same refresh rate. There are extra settings available to adjust how the board converts the external sync to the internal sync:

- ▶ Select which edge of external sync pulse triggers the internal pulse, leading, trailing, or on TTL both

- ▶ Identify that the incoming signal is interlaced
- ▶ Set a **Sync Interval** defining how many incoming external sync pulses need to be received before the Quadro Sync board sends an internal pulse
 - The default value is 0, meaning every external packet is sent internally
 - Setting 1 will cause the Quadro Sync board to send every other received pulse causing the internal sync pulses to run at half the speed of the external
- ▶ Define a start **Sync Delay** in μ Seconds between the external signal and internal sync pulses

Synchronize to an External Sync Source for Windows

1. Open the **NVIDIA Control Panel** and select **Synchronize Displays**
2. Select **“The timing server is On this system”** radio button
3. Click the **Server Settings** button
4. Select **An external house sync signal**
5. Adjust the other options as needed
6. Press **OK**

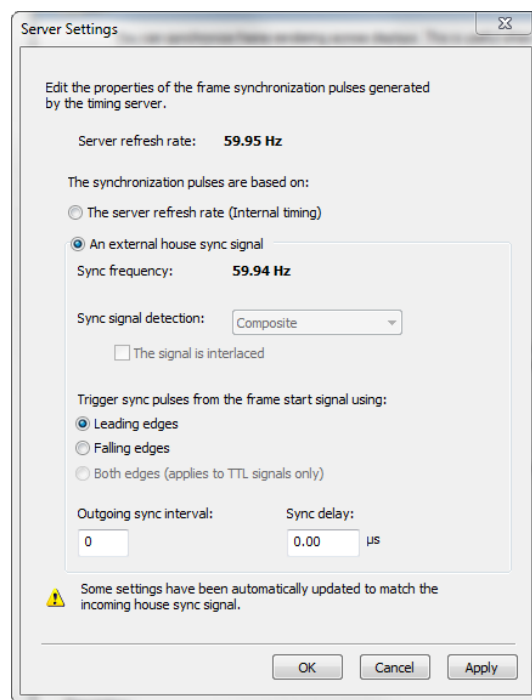

Synchronize to an External Sync Source for Linux

1. Open the **NVIDIA X Server Settings** and select **Frame Lock**
2. Add Device if needed and configure a display to be the timing server
3. Select **Use House Sync If Present** and define and other options needed

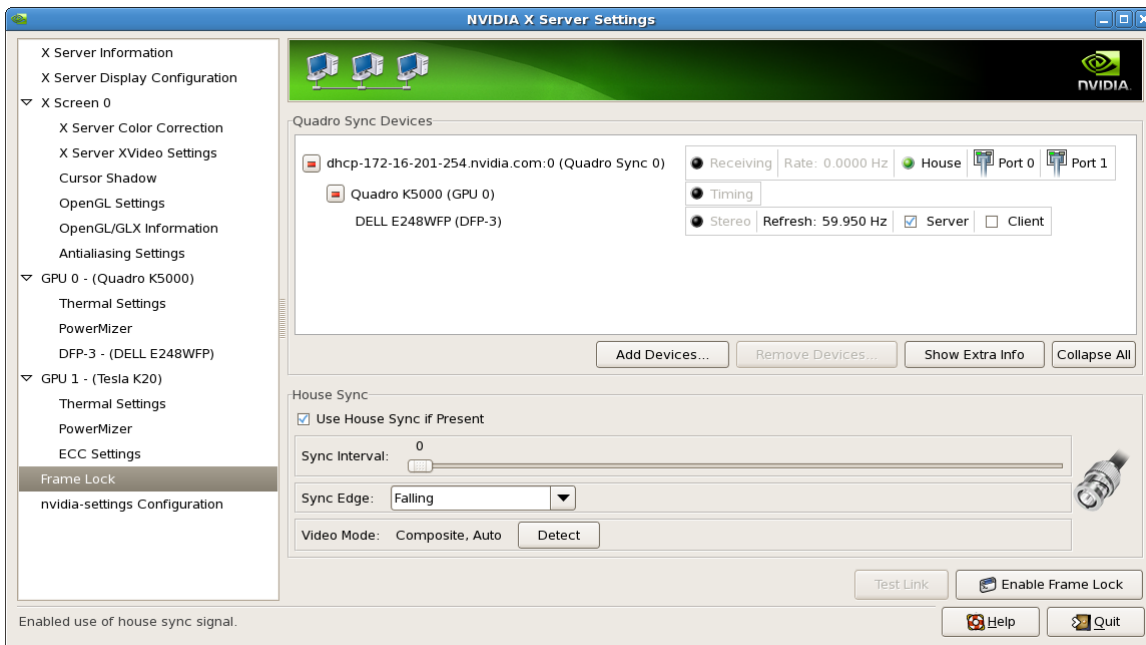

4. Press **Enable Frame Lock**
5. Once enabled the UI will reflect the status in the Device list and the House Sync options will be grayed out until Frame Lock is disabled

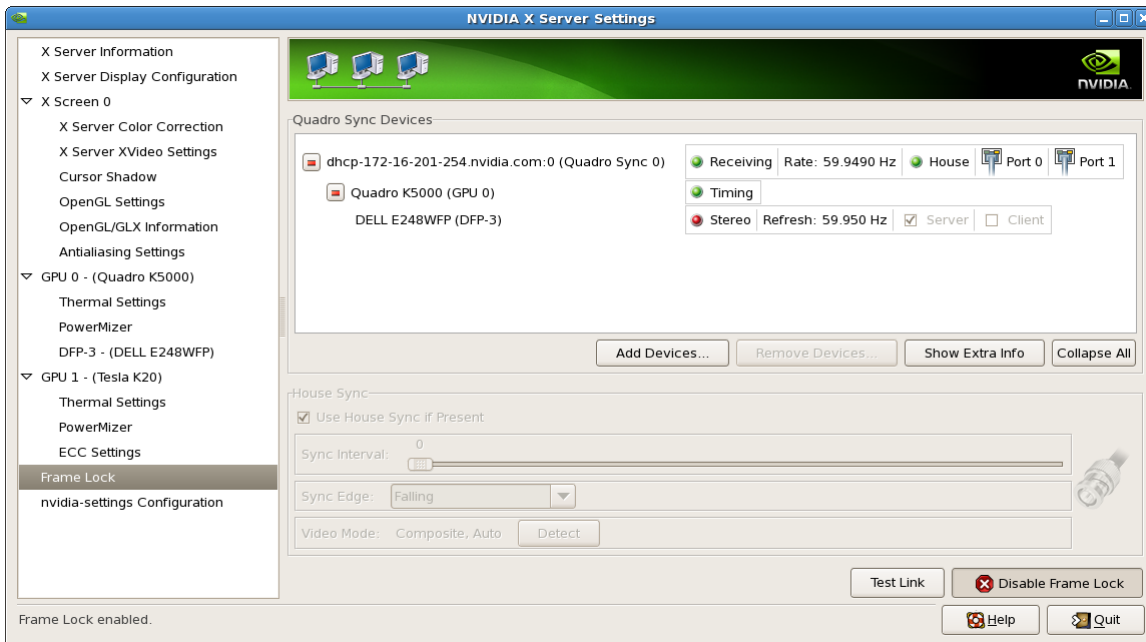

MONITORING DISPLAY SYNCHRONIZATION

When working with synchronized displays it can often be difficult to verify that all the displays are correctly synchronized. Quadro Sync provides both board and driver level indicators for the synchronization status.

BOARD LEVEL STATUS INDICATOR

The bracket of the Quadro Sync boards has multiple lights to provide configuration and status information

At system startup all LED's will turn and stay on until the graphics driver loads. Once the driver loads, the LEDs will start to show the status of the board and GPUs.

If the LEDs do not turn on at startup, verify that the external power is correctly connected and providing power.

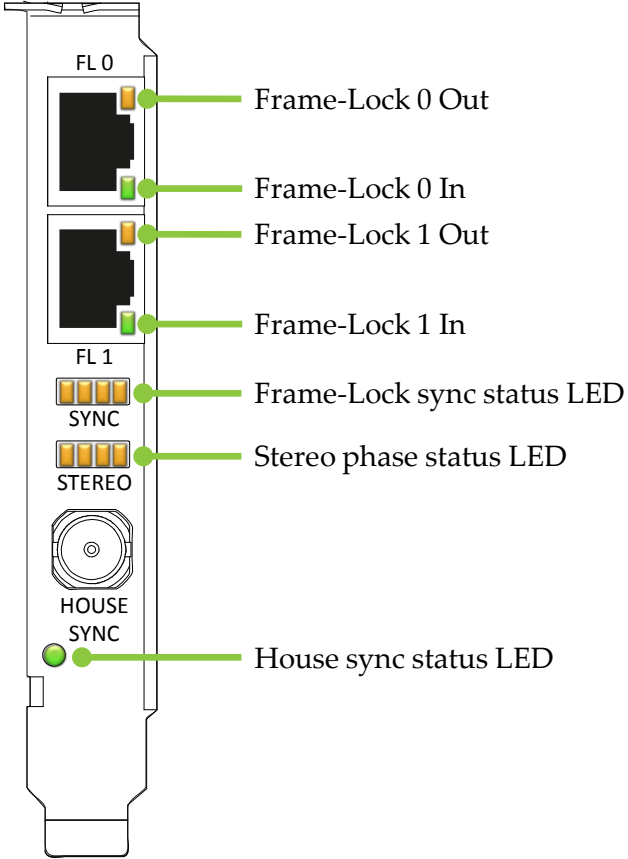

Figure 6. Board Level Status Indicators

Note: : If the LED's on the bracket do not turn on at system start-up shutdown the system and verify the external power to the Quadro Sync board is connected and operating correctly.

Frame Lock and Stereo Sync Status LEDs

The two rows of status LEDs provide information on the current state of synchronization of the board. There is one LED for each of the GPUs that can be connected.

The top row of LED's shows the synchronization status of the connected GPUs.

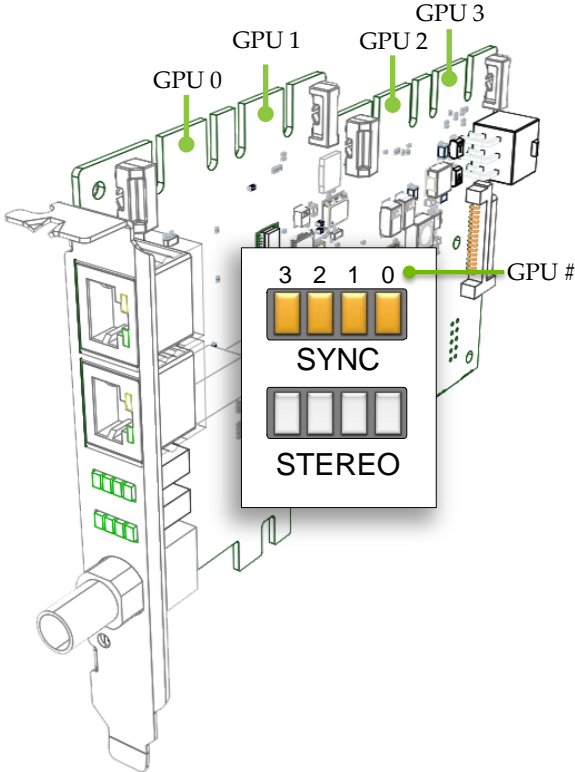









Figure 7. Frame Lock and Stereo Sync Status LEDs

SYNC LED Status

-  GPU Not connected
-  GPU present but not synchronized
-  GPU synchronized
-  GPU is synchronized but within 5% of the threshold of losing sync
-  GPU is synchronizing

STEREO LED Status

-  Stereo not active/no GPU
-  Stereo locked
-  Stereo in process of locking

SYSTEM TOPOLOGY VIEWER FOR WINDOWS

The System Topology Viewer provides a single screen overview of the GPU, displays and synchronization status.

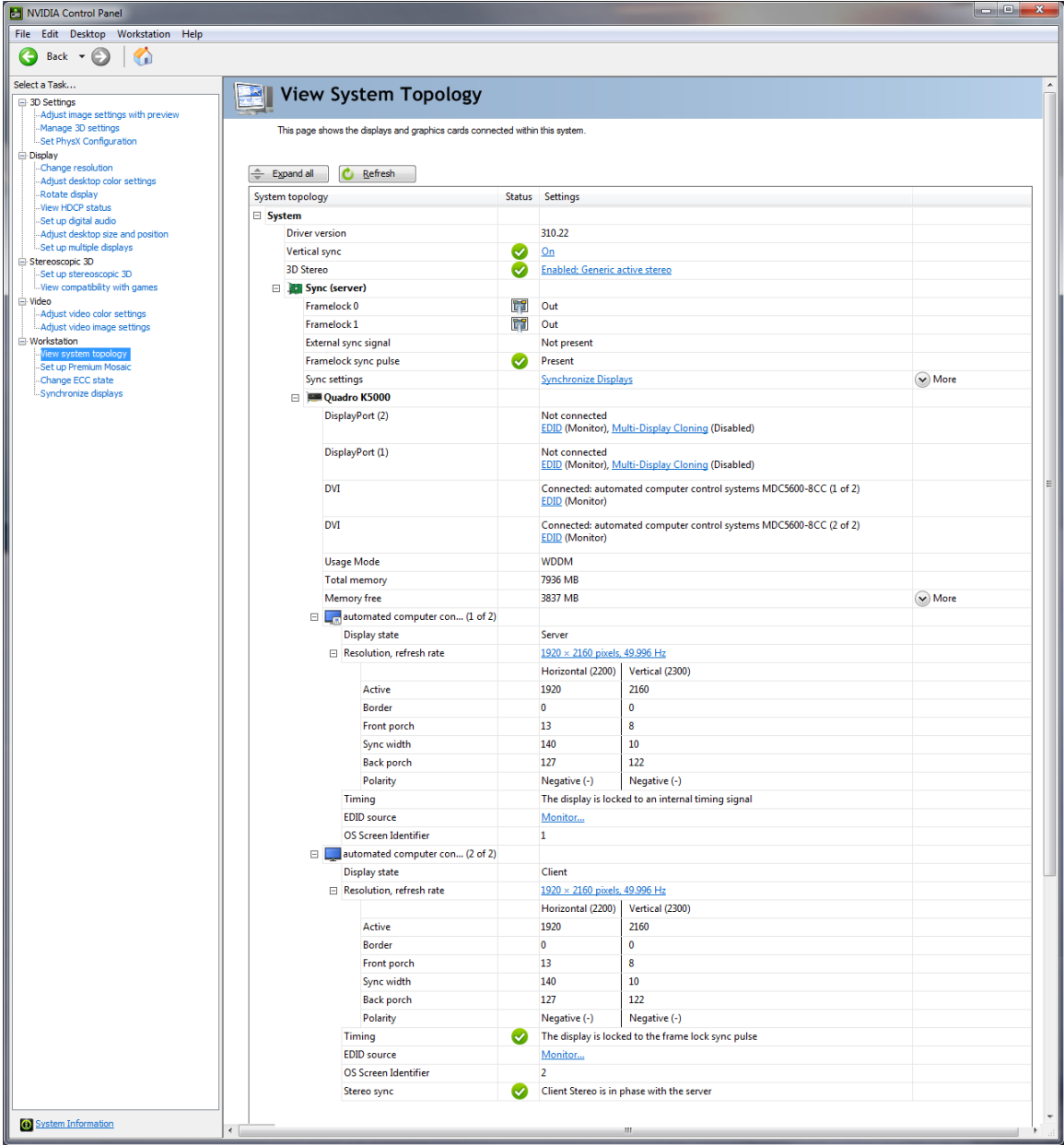

Figure 8. System Topology Viewer for Windows

To use the topology viewer:

1. Open the **NVIDIA Control Panel** and select **View System Topology**
2. With multiple GPUs and displays, the Topology Viewer can get large, maximizing the control panel is recommended.
3. Start at the top and work down the page
 - a) Sync Board Settings, verify that the **FrameLock sync pulse** and **External sync signal** are as expected

System topology	Status	Settings
System		
Driver version		310.22
Vertical sync	✓	On
3D Stereo	✓	Enabled; Generic active stereo
Sync (server)		
FrameLock 0	Out	
FrameLock 1	Out	
External sync signal	Not present	
FrameLock sync pulse	✓	Present
Sync settings		Synchronize Displays
Quadro K5000		

- b) Scroll down to the individual displays within the GPUs.
- c) Verify the **Timing** entry for the Server is locked to the internal or external timing

automated computer con... (1 of 2)	Server
Display state	Server
Resolution, refresh rate	1920 x 2160 pixels, 49.996 Hz
	Horizontal (2200) Vertical (2300)
Active	1920 2160
Border	0 0
Front porch	13 8
Sync width	140 10
Back porch	127 122
Polarity	Negative (-) Negative (-)
Timing	The display is locked to an internal timing signal
EDID source	Monitor...
OS Screen Identifier	1

- d) For the other displays verify they are **locked** to the sync pulse and that **Stereo is in phase** if using stereo

automated computer con... (2 of 2)	Client
Display state	Client
Resolution, refresh rate	1920 x 2160 pixels, 49.996 Hz
	Horizontal (2200) Vertical (2300)
Active	1920 2160
Border	0 0
Front porch	13 8
Sync width	140 10
Back porch	127 122
Polarity	Negative (-) Negative (-)
Timing	✓ The display is locked to the frame lock sync pulse
EDID source	Monitor...
OS Screen Identifier	2
Stereo sync	✓ Client Stereo is in phase with the server

SYNC TIMING LIMITS

The Quadro Sync board has the ability to align displays and sync sources up to ± 20 ppm difference in the display timings. If the timings are outside this range the board will not be able to synchronize them. The Frame Lock status LEDs on the board will indicate that the board is approaching these limits as well.

Table 1. Sync Timing Limits

Display Refresh Rate (Hz)	Minimum (Hz)	Maximum (Hz)
200	199.996	200.004
120	119.9976	120.0024
100	99.998	100.002
60	59.9988	60.0012
50	49.999	50.001

COMPLIANCE AND CERTIFICATIONS

The Quadro Sync board is compliant with the following regulations:

- ▶ Australian Communications Authority and Radio Spectrum Management Group of New Zealand (C-Tick)
- ▶ Bureau of Standards, Metrology and Inspection (BSMI)
- ▶ China Compulsory Certification (CCC)
- ▶ Conformité Européenne (CE)
- ▶ Federal Communications Commission (FCC) – Class B
- ▶ Interference-Causing Equipment Standard (ICES)
- ▶ Imaging Science Foundation (ISF)
- ▶ Korean Communication Commissions (KCC)
- ▶ Underwriters Laboratories (UL, CUL)
- ▶ Voluntary Control Council for Interference (VCCI)

IMPORTANT SAFETY INFORMATION

NVIDIA products are designed to operate safely when installed and used according to the product instructions and general safety practices. The guidelines included in this document explain the potential risks associated with equipment operation and provide important safety practices designed to minimize these risks. By carefully following the information contained in this document, and the specific instructions provided with your product, you can protect yourself from hazards and create a safer environment.

The product is designed and tested to meet IEC-60950-1, the Standard for the Safety of Information Technology Equipment. This also covers the national implementation of IEC-60950-1 based safety standards around the world e.g. UL-60950-1. These standards reduce the risk of injury from the following hazards:

- ▶ **Electric shock:** Hazardous voltage levels contained in parts of the product
- ▶ **Fire:** Overload, temperature, material flammability
- ▶ **Mechanical:** Sharp edges, moving parts, instability
- ▶ **Energy:** Circuits with high energy levels (240 volt amperes) or potential as burn hazards
- ▶ **Heat:** Accessible parts of the product at high temperatures
- ▶ **Chemical:** Chemical fumes and vapors
- ▶ **Radiation:** Noise, ionising, laser, ultrasonic waves



Retain and follow all product safety and operating instructions. Always refer to the documentation supplied with your equipment. Observe all warnings on the product and in the operating instructions.



CAUTION: Failure to follow these safety instructions could result in fire, electric shock, or other injury or damage.

To reduce the risk of bodily injury, electric shock, fire, and damage to the equipment observe the safety labels included on the equipment.

Table 2. Symbols on Equipment

Sign	Meaning
	<p>This symbol in conjunction with any of the following symbols indicates the presence of a potential hazard. The potential for injury exists if warnings are not observed. Consult your documentation for specific details</p>
	<p>This symbol indicates the presence of hazardous energy circuits or electric shock hazards. Refer all servicing to qualified personnel.</p> <p>WARNING: To reduce the risk of injury from electric shock hazards, do not open this enclosure. Refer all maintenance, upgrades, and servicing to qualified personnel.</p>
	<p>This symbol indicates the presence of electric shock hazards. The area contains no user or field serviceable parts. Do not open for any reason.</p> <p>WARNING: To reduce risk of injury from electric shock hazards, do not open this enclosure.</p>

Notice

ALL NVIDIA DESIGN SPECIFICATIONS, REFERENCE BOARDS, FILES, DRAWINGS, DIAGNOSTICS, LISTS, AND OTHER DOCUMENTS (TOGETHER AND SEPARATELY, "MATERIALS") ARE BEING PROVIDED "AS IS." NVIDIA MAKES NO WARRANTIES, EXPRESSED, IMPLIED, STATUTORY, OR OTHERWISE WITH RESPECT TO THE MATERIALS, AND EXPRESSLY DISCLAIMS ALL IMPLIED WARRANTIES OF NONINFRINGEMENT, MERCHANTABILITY, AND FITNESS FOR A PARTICULAR PURPOSE.

Information furnished is believed to be accurate and reliable. However, NVIDIA Corporation assumes no responsibility for the consequences of use of such information or for any infringement of patents or other rights of third parties that may result from its use. No license is granted by implication of otherwise under any patent rights of NVIDIA Corporation. Specifications mentioned in this publication are subject to change without notice. This publication supersedes and replaces all other information previously supplied. NVIDIA Corporation products are not authorized as critical components in life support devices or systems without express written approval of NVIDIA Corporation.

Trademarks

NVIDIA, the NVIDIA logo, Quadro, and SLI are trademarks and/or registered trademarks of NVIDIA Corporation in the U.S. and other countries. Other company and product names may be trademarks of the respective companies with which they are associated.

Copyright

© 2012 NVIDIA Corporation. All rights reserved.